

DIN RAILS

TRULY INDUSTRIAL

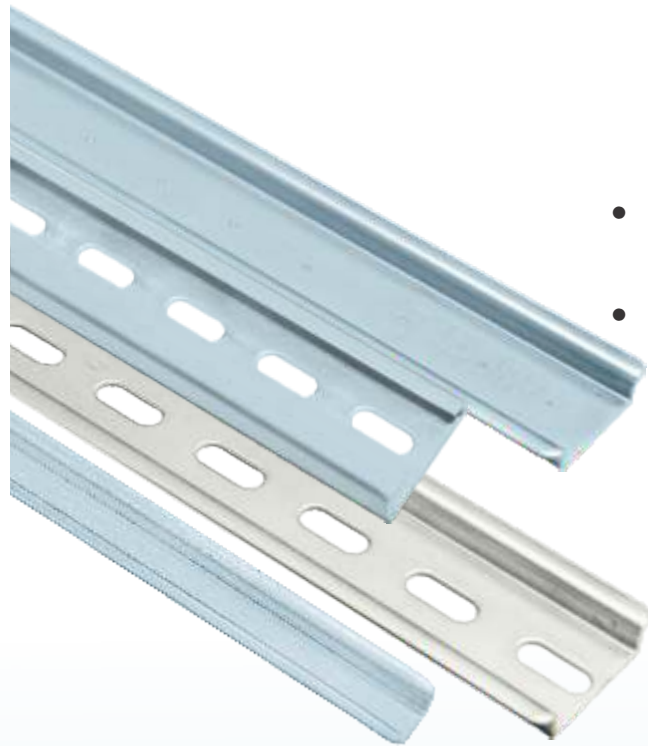
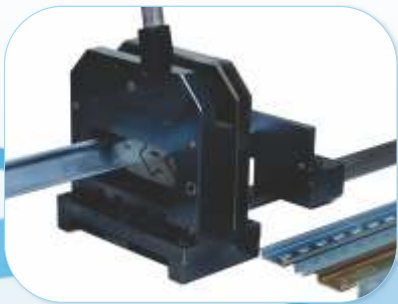
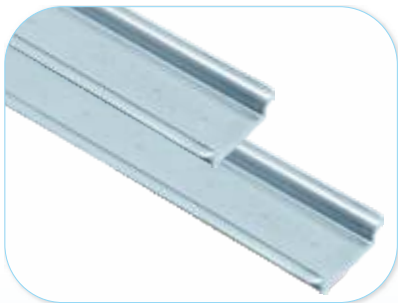

- PERFORATED
- UN-PERFORATED

CE 

SIMPLY SOLUTIONS

Truly Industrial

DIN Rails



White passivated plus zinc plated, for indoor installation

Thick layer passivated plus zinc plated, for indoor and protected outdoor installation

White passivated plus zinc plated, for indoor installation

DIN 'G' Rail 32/15

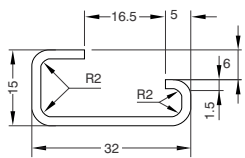

Type	TDR2 (White)		TDR3 (Silver)		TBLS (White)	
Length	2 Meter	1 Meter	2 Meter	1 Meter	2 Meter	1 Meter
Article no. for Un-perforated	01 17 01128	01 17 01130	01 17 01124	01 17 01126	01 17 01132	01 17 01134
Article no. for Perforated - 15mm/M6 Screw width	01 17 01129	01 17 01131	01 17 01125	01 17 01127	01 17 01133	01 17 01135
Meters/Box	20	10	20	10	20	10
Box Size (L x H x W mm)	2010 x 40 x 90	1020 x 40 x 87	2010 x 40 x 90	1020 x 40 x 87	2010 x 40 x 90	1020 x 40 x 87

DIN Rail 15/5.5

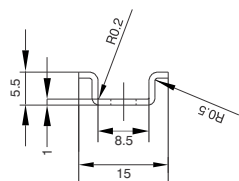

Type	TDR2 (White)		TDR3 (Silver)		TBLS (White)	
Length	2 Meter	1 Meter	2 Meter	1 Meter	2 Meter	1 Meter
Article no. for Un-perforated	01 17 00252	01 17 00253	01 17 00277	01 17 00278	01 17 00321	01 17 00322
Article no. for Perforated - 12mm/M4 Screw width	01 17 00254	01 17 00255	01 17 00279	01 17 00280	01 17 00323	01 17 00324
Meters/Box	80	40	80	40	80	40
Box Size (L x H x W mm)	2010 x 40 x 90	1020 x 40 x 87	2010 x 40 x 90	1020 x 40 x 87	2010 x 40 x 90	1020 x 40 x 87

Features

- The design of the DIN rails complies with European standard EN 60715.
- Particular attention has been paid to a high degree of dimensional accuracy and surface tempering.
- All DIN rails are also available cut to length.

The DIN rails are available with various surface coatings and are suitable for the following installation :

- White passivated plus zinc plated, for indoor installation.
- Thick layer passivated plus zinc plated, for indoor and protected outdoor installation.
- Made of copper may be used as grounding bus bars (PE function) as well as neutral bus bar (PEN function).
- Available for M4, M5, M6 screw width.

White passivated plus zinc plated, for indoor installation

Thick layer passivated plus zinc plated, for indoor and protected outdoor installation

White passivated plus zinc plated, for indoor installation

Made of copper may be used as grounding bus bars (PE function) as well as neutral bus bar (PEN function)

DIN Rail 35/7.5

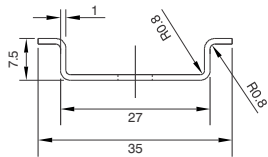

Type	TDR2 (White)		TDR3 (Silver)		TBLS (White)		TDRC (Copper)	
	2 Meter	1 Meter	2 Meter	1 Meter	2 Meter	1 Meter	2 Meter	1 Meter
Length								
Article no. for Un-perforated	01 17 00256	01 17 00270	01 17 00281	01 17 00282	01 17 00329	01 17 00330	01 17 01208	01 17 01212
Article no. for Perforated - 15mm/M6 Screw width	01 17 00271	01 17 00272	01 17 00283	01 17 00284	01 17 00331	01 17 00332	01 17 01207	01 17 01211
Article no. for Perforated - 18mm/M6 Screw width	01 17 04455	01 17 04456	01 17 04453	01 17 04454	01 17 04988	01 17 04989		
Article no. for Perforated - 25mm/M5 Screw width	01 17 04872	01 17 04871	01 17 04874	01 17 04873	01 17 04868	01 17 04867		
Meters/Box	40	20	40	20	40	20	40	20
Box Size (L x H x W mm)	2010 x 40 x 90	1020 x 40 x 87	2010 x 40 x 90	1020 x 40 x 87	2010 x 40 x 90	1020 x 40 x 87	2010 x 40 x 90	1020 x 40 x 87

DIN Rail 35/15

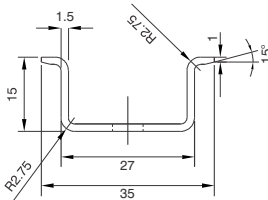

Type	TDR2 (White)		TDR3 (Silver)		TBLS (White)		TDRC (Copper)	
	2 Meter	1 Meter	2 Meter	1 Meter	2 Meter	1 Meter	2 Meter	1 Meter
Length								
Article no. for Un-perforated	01 17 00273	01 17 00274	01 17 00285	01 17 00286	01 17 00337	01 17 00338	01 17 01206	01 17 01210
Article no. for Perforated - 15mm/M6 Screw width	01 17 00275	01 17 00276	01 17 00287	01 17 00288	01 17 00339	01 17 00340	01 17 01205	01 17 01209
Meters/Box	20	10	20	10	20	10	20	10
Box Size (L x H x W mm)	2010 x 40 x 90	1020 x 40 x 87	2010 x 40 x 90	1020 x 40 x 87	2010 x 40 x 90	1020 x 40 x 87	2010 x 40 x 90	1020 x 40 x 87

Customised DIN Rails

Application:

For pre design mounting of MCB

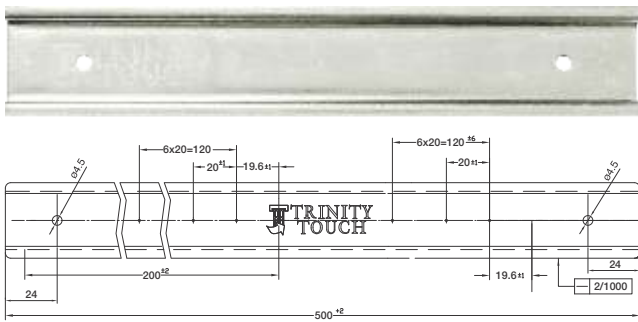
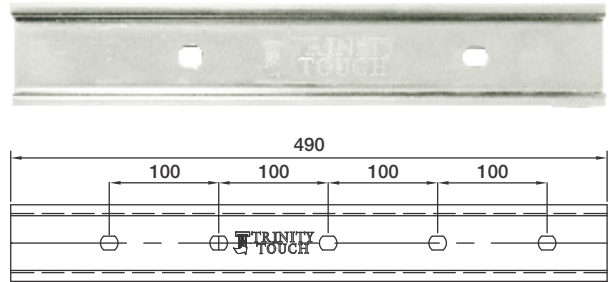

Application:

For pre design mounting in custom enclosure

Application:

For customised fastener

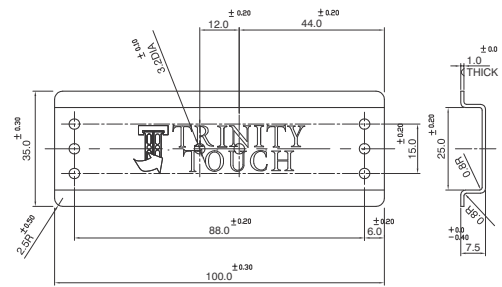

Perforation for Screw Width

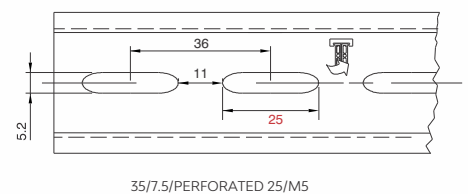
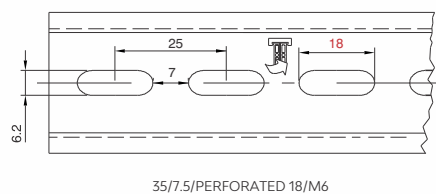
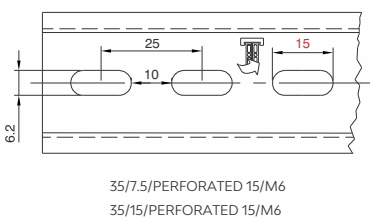
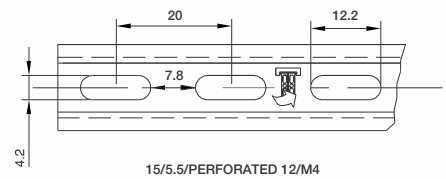
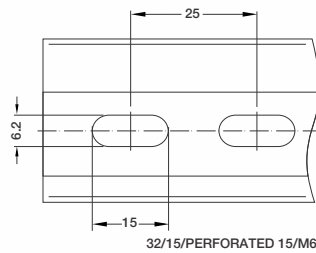

Specifications of DIN Rails

Description	Units	TDR2	TDR3	TBLS	TDRC
Designed in accordance / similar to EN 60715		✓	✓	✓	✓
Base metal - cold rolled low carbon steel according to DIN EN 10130		✓	✓	✓	ETP grade copper
Electroplated coating of zinc according to DIN EN 12329		✓	✓	✓	Un-coated
Passivation according to DIN EN 12329		✓	✓	✓	
Electroplated coating Fe//Zn8//B		✓		✓	
Electroplated coating Fe//Zn12//C			✓		
Zinc layer thickness	µm	6-8	8-12	3-5	
Passivation film thickness	nm	200-400	300-400		
Colour appearance		Light iridescence (White)	Iridescence (Silver)		Copper coloured
NSS neutral salt spray White Rust (Minimum), Corrosion Stability	Hours	72	120	48	
NSS neutral salt spray Red Rust (Minimum), Corrosion Stability	Hours	120	240	72	
RoHS Compliances		✓	✓	✓	✓
CE Compliances		✓	✓		
May be used as grounding busbars (PE function) according to IEC 60947-7-2			✓		✓
Standard length	Meter	1 or 2	1 or 2	1 or 2	1 or 2
Availability in custom cut to length		✓	✓	✓	✓

Universal DIN Rail Cutter

Bench top profile cutter with five built in dies for manual cutting of common DIN rails to custom length. Tool is intended for use where multiple DIN rails are to be cut without changing the die.



Salient Features

- Long life of punch and side plates.
- Nickel-chrome plated handle.
- Ease of operation.
- Cuts in flash and without burr or deformation.
- Guide plate facilitates insertion of profile and provides rail support.
- Direct reading rail length indicator (Scale).
- Common cutting die for 32/15, 35/7.5, 35/15, 15/5.5 DIN Rails as well as neutral busbars NLS CU 3/10.

Description	Type	Article No.	Pkt.
Profile cutter, with inch/mm measuring bar	PC Series 1-I/M	0117 00269	1

OTHER PRODUCT PROGRAMS

TRIBOX® Thermoplastic Enclosures



IP 67
IP 69K
CE
RoHS

TRIBOX® Aluminium Enclosures & FRP Enclosures



IP 66/67
IP 69
HALOGEN FREE
CE
RoHS
UL
IP66
IP67
IP68
IK10

Wiring Ducts

Wire Management Solutions
PVC & Halogen Free



REACH
CERTIFIED
UL
US
CE
RoHS
CS

Cable Glands

With Wide Clamping Range



IP68
UL
US
CE
RoHS

Solderless Terminals



RoHS

Interface Modules



CE
RoHS

Analog Timers



CE
RoHS

TRISOLAR®



TRIBOX® Customised Solutions



IP 66/67
IP 67/68

Trinity Touch Pvt. Ltd.

www.trinitytouch.com

INDIA

Delhi: Corporate Office

D-10, Defence Colony, New Delhi
110024, INDIA

Tel: +91.11.71200900

Fax: +91.11.71200998

E-mail: postmaster@trinitytouch.com

Bangaluru

2nd Floor, Umiya Land Mark 10/7,
Lavelle Road, Bangaluru 560001, INDIA
Tel: +91.80.46231200

Pune

'Devi House', 3rd Floor, Plot No.37,
CTS No.1576, Shivaji Nagar, Behind
Hotel Pride Executive, Pune 411005, INDIA
Tel: +91.20.71999600

Works & Warehouse

Prithla-Dudhola road, Dudhola Distt. Palwal,
Haryana 121102, INDIA

Tel: +91.1275.711500

E-mail: sales@trinitytouch.com

Trinity Touch (EUROPE) Ltd.

www.trinitytouch.co.uk

UK

Unit-L, Tyson Courtyard, Weldon South
Industrial Estate, Corby, Northants,
N N18 8AZ, UK

Tel: +44 (0) 1536 400 641

Fax: +44 (0) 1536 268 043

E-mail: gbsales@trinitytouch.com

Trinity Touch (South East Asia) Pte. Ltd.

SINGAPORE

No.72, Eunos Ave 7, #06-03 Singapore
Handicrafts Building, Singapore 409570

Distributed by :